

Reception Teacher's Handbook

Phase Three Week 1

Resource Pack

Contents

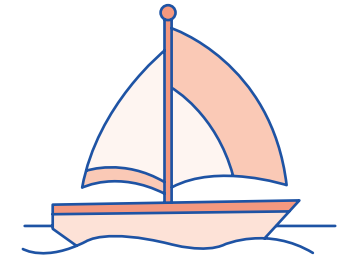

Mnemonic for j	1	Matching pictures for w and x	13
Mnemonic for v	2	Question cards for j	15
Mnemonic for w	3	Grapheme cards: j, v, w	21
Mnemonic for x	4	Captions and matching pictures for v	22
Word cards for j	5	Phase Two Three-box phoneme frame	26
Word cards for v	7	Phase Two and Phase Three Phoneme frame letters: w, j, v, e, ll, b, t	27
Word cards for w	9	Read and find sentences for x	28
Word cards for x	11		

Note: Please refer to the Phase Two Resource Packs for the Phase Two Word cards, Phase Two Grapheme cards and Phase Two High-frequency word cards.

Mnemonic for j

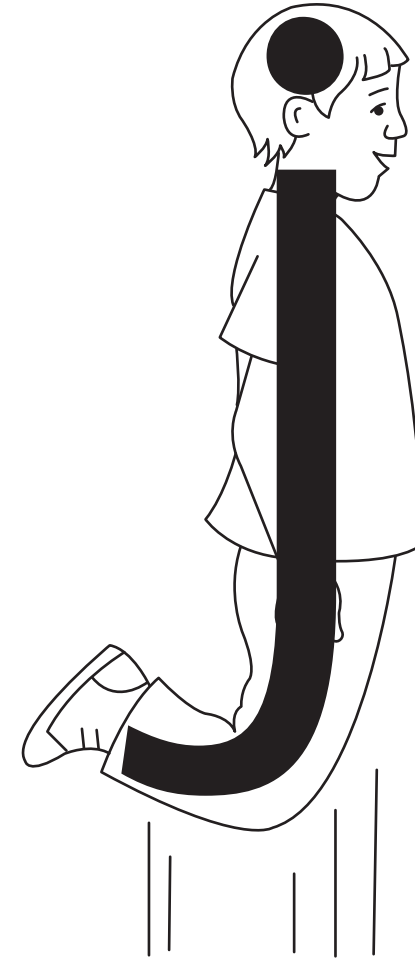
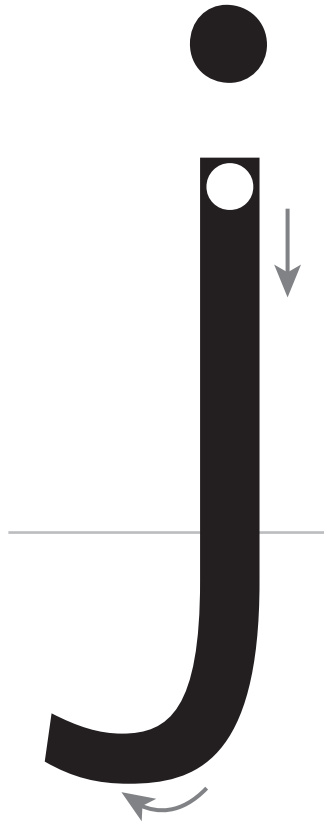

Mnemonic for v

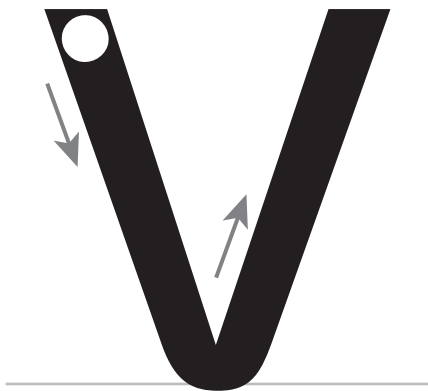

Mnemonic for w

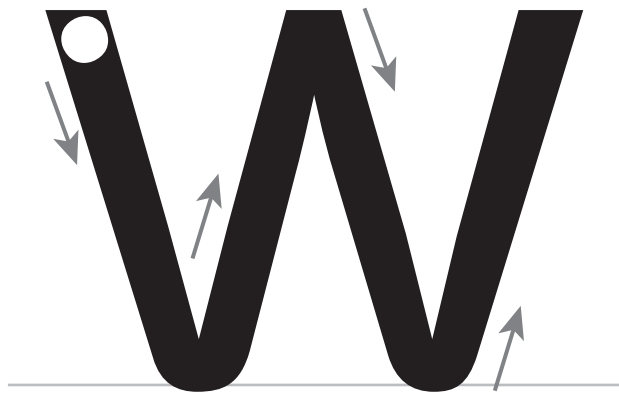

Mnemonic for x

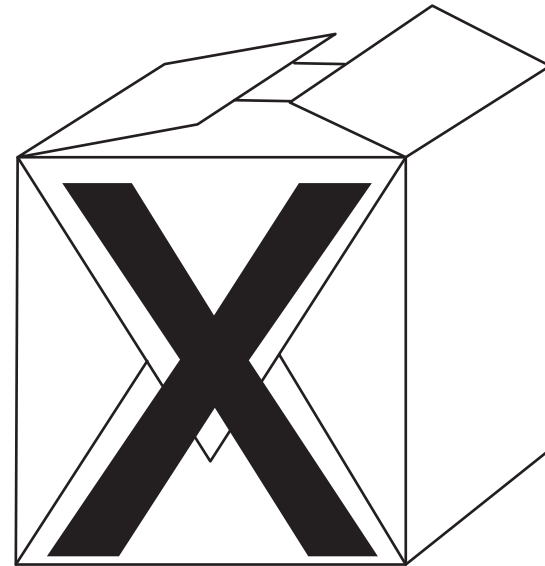
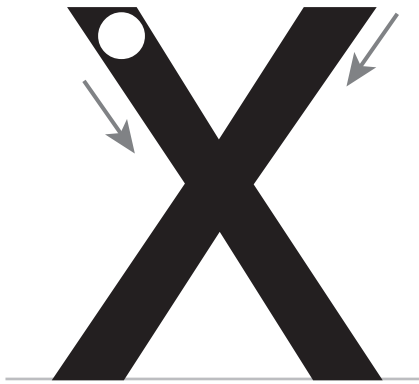

Word cards for j

jog
● ● ●

jam
● ● ●

jet
● ● ●

job

Word cards for **j** continued

jig

jab

jug

Jack

Jill

jot

Word cards for v

van



vet



Val



vat

Word cards for **v** continued

Dev

Vic

visit

Word cards for w

will



well



win



wag

wig

web

Word cards for **w** continued

wet

wed

wit

wick

cobweb

Word cards for x

mix



six



fix



fox

Word cards for **x** continued

box

wax

ox

Rex

Max

exit

Matching pictures for **w** and **x**

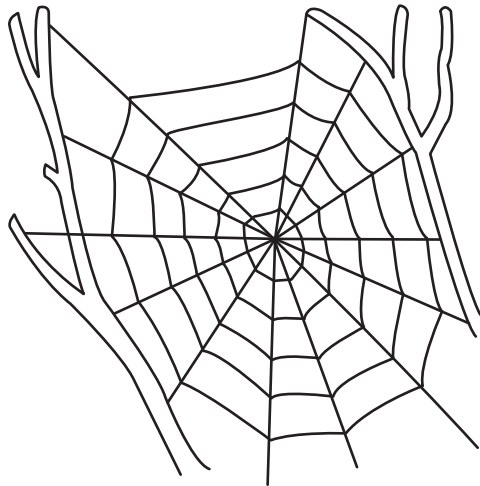
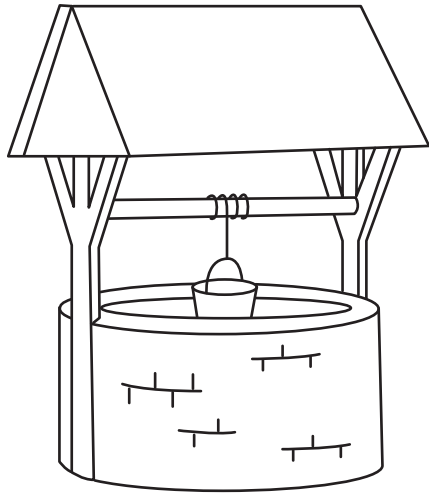

Matching pictures for **w** and **x** continued

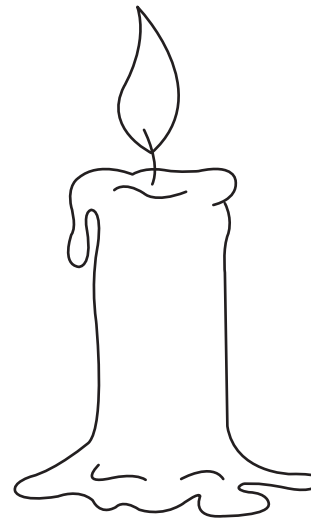
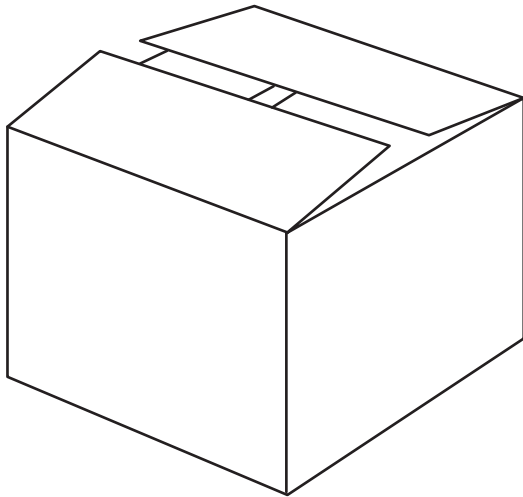
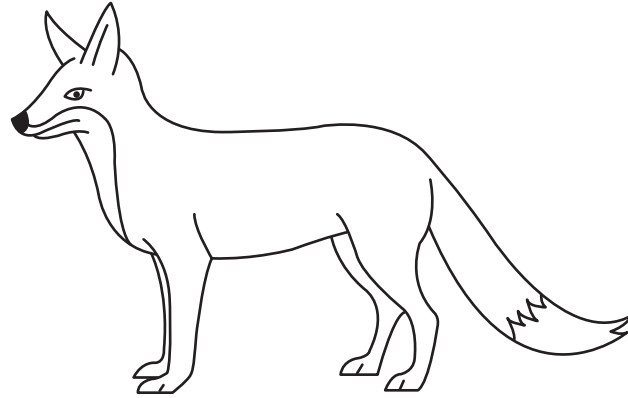
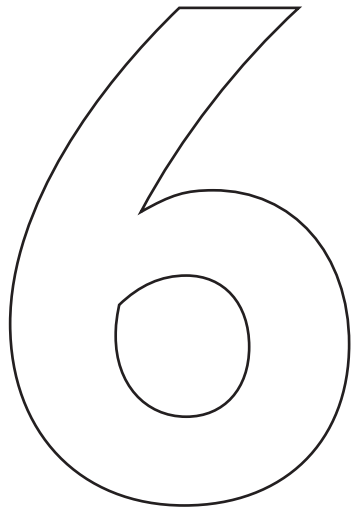

Can the jug go to bed?

Can the hen get a job?

Am I as big as a jet?

Can a rock go
to get jam?

Can a duck jog?

Can a pig jig?

Grapheme cards: **j, v, w**

j

v

w

Dev and Val go to
visit Nan.

a visit to the mill

a visit to the vet

Captions and matching pictures for **v** continued

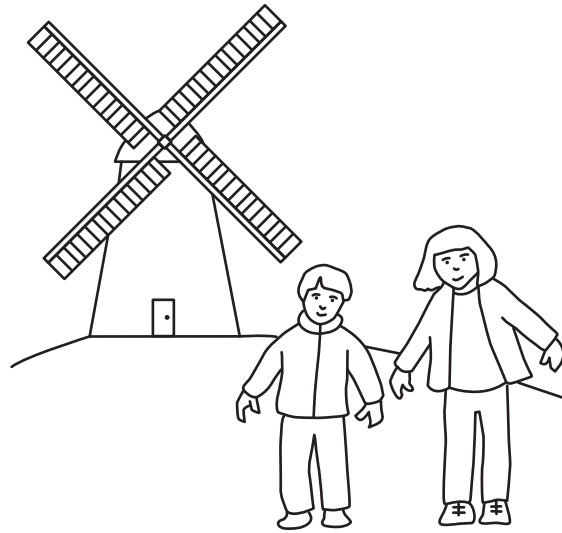
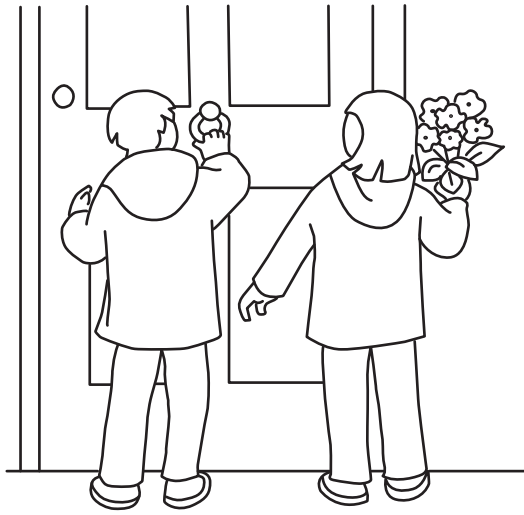

Phase Two Three-box phoneme frame

--	--	--

Tog speaks in sound-talk.

Break up words into sounds like Tog.

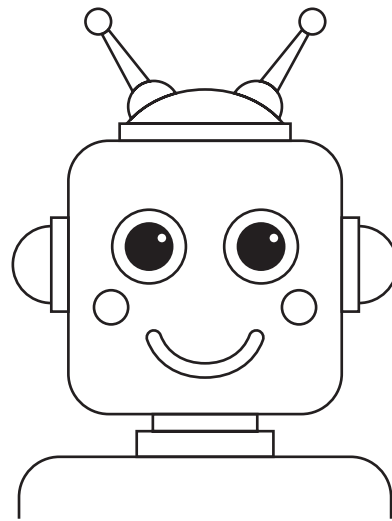

Phase Two and Phase Three Phoneme frame letters: **w, j, v, e, ll, b, t**

w

j

v

e

ll

b

t

Read and find sentences for **x**

The red wig is in
the box.

Jim put the six in
the box.

A fox cub hid in
the box.